

EFI ENERGIES

BUREAU D'ETUDES ENERGETIQUE

VOTRE PARTENAIRE ENERGETIQUE

1. LA SOCIETE

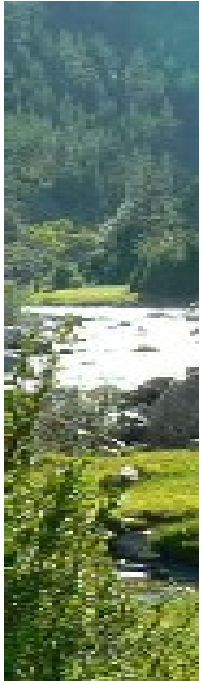

EFI ENERGIES en quelques mots :

- bureau d'études **indépendant** créé en 2005
- une équipe de 6 ingénieurs motivés
- une intervention dans les 4 domaines suivants :

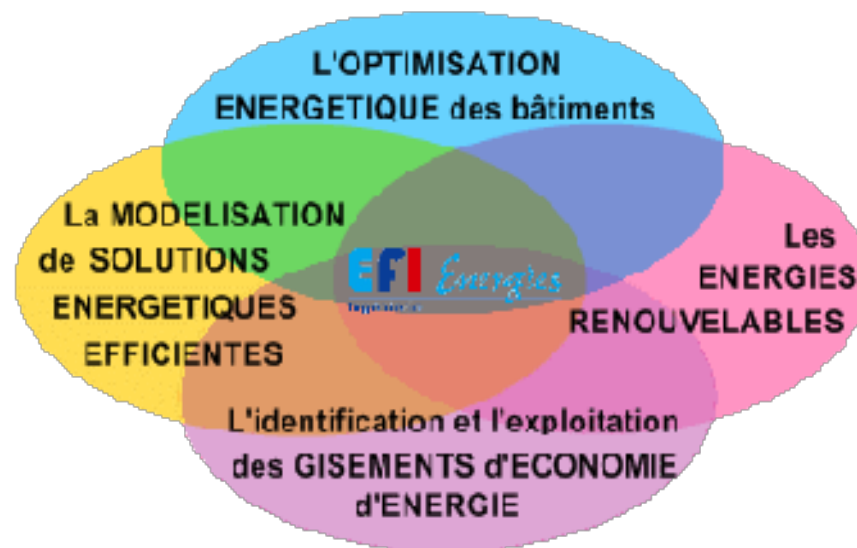

2. DOMAINES D'INTERVENTION

EFI ENERGIES peut assurer la prise en charge totale d'un projet énergétique

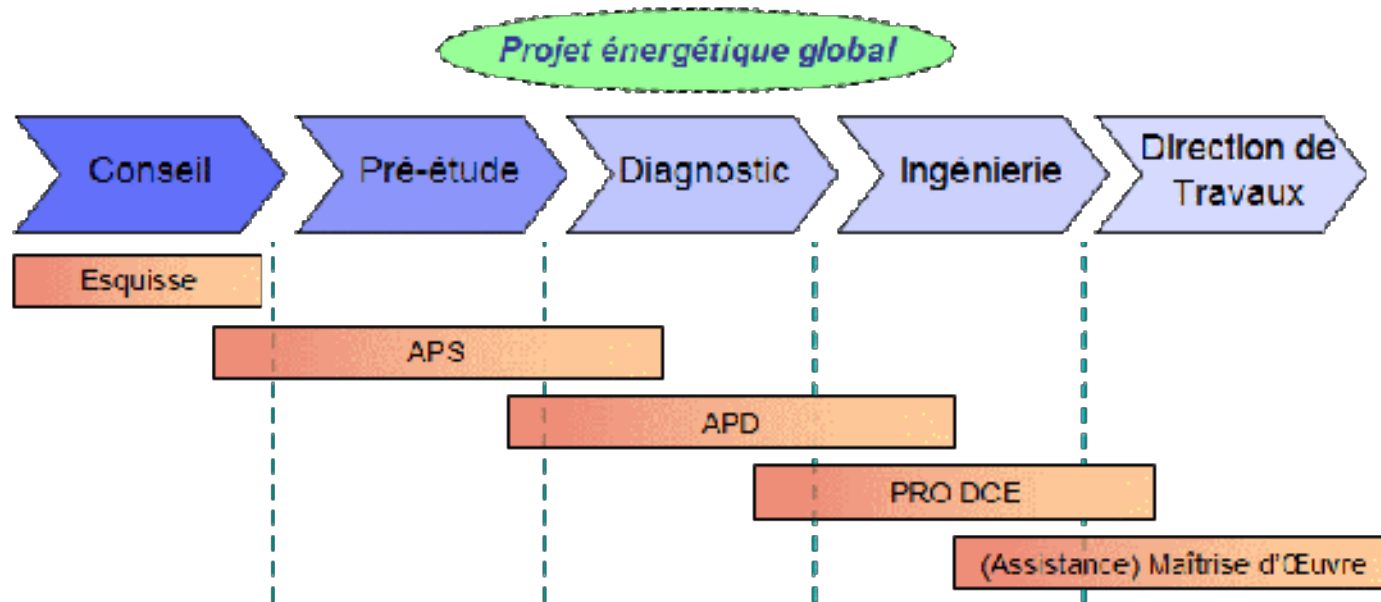

2. DOMAINES D'INTERVENTION : INGENIERIE

Analyse de toute la chaîne consommatrice d'énergie

Production

Fluides

Distribution

Régulation

Emission

Identification des gisements d'économie d'énergie

Géo-
construction

Matériaux de
construction

Isolation et
port thermique

Apports
gratuits

Ventilation

Réglementation

Analyse du comportement humain et des habitudes des usagers

2. DOMAINES D'INTERVENTION : DIAGNOSTIC ENERGETIQUE

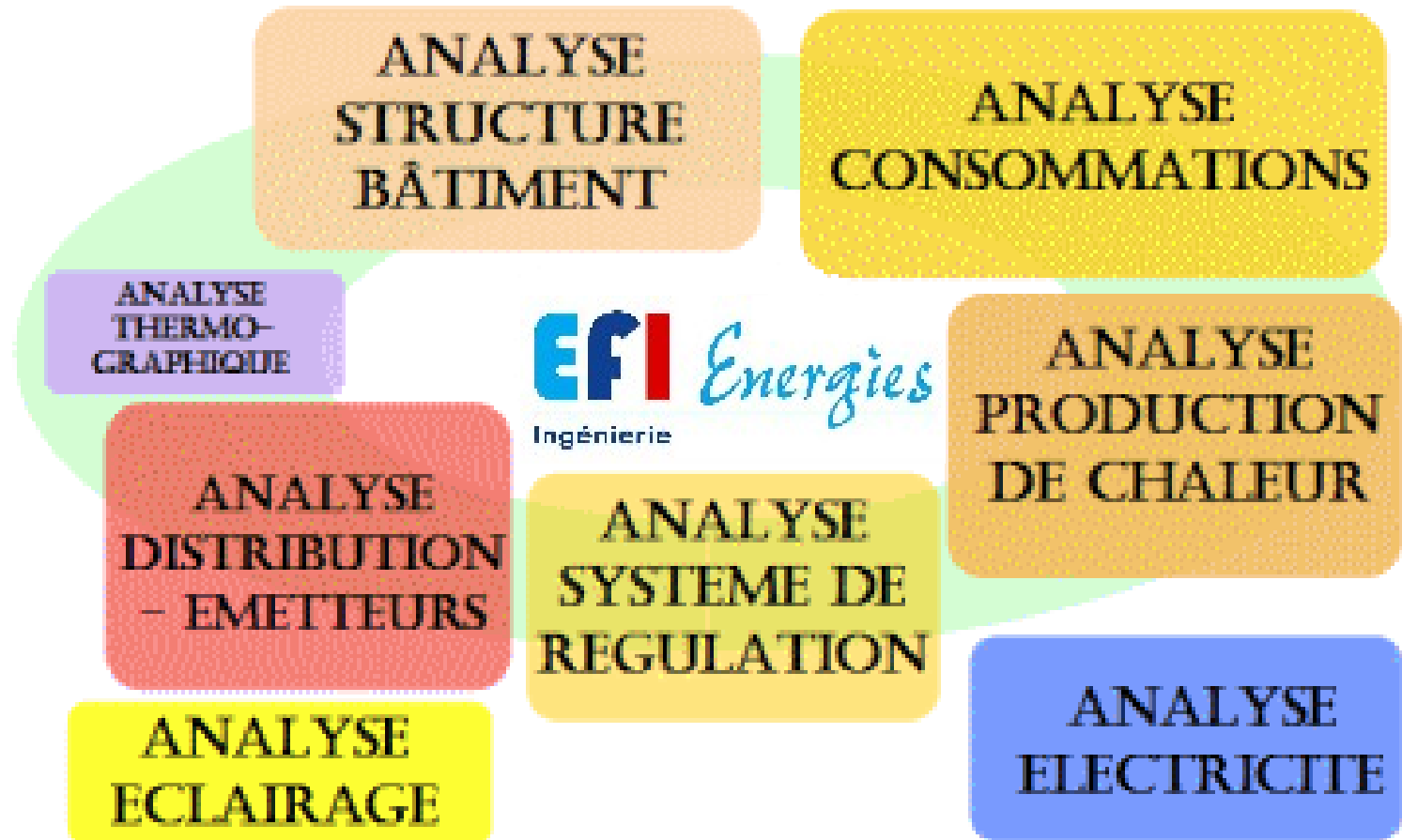

2. DOMAINES D'INTERVENTION : NOUVELLE CONSTRUCTION

EFI ENERGIES propose des solutions pour atteindre des **objectifs fixés en terme de consommation** et de réglementation, en optimisant le **confort** et en tenant compte de votre **enveloppe budgétaire** :

Consommation en kWh ep/m²/an pour les besoins de chauffage, climatisation, ventilation et production d'eau chaude sanitaire

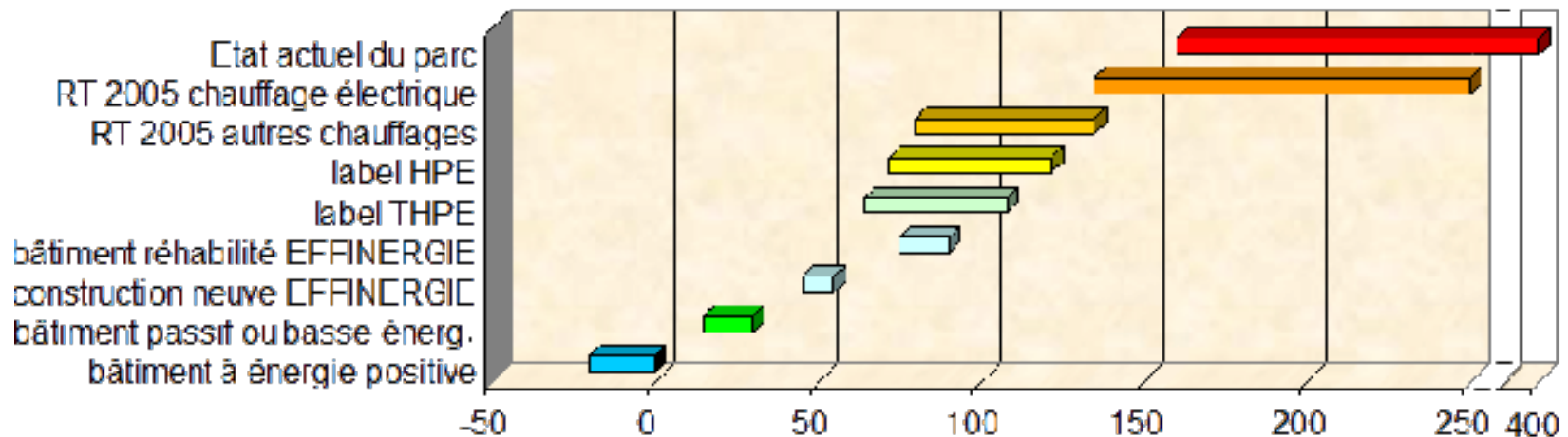

EFI ENERGIES est également en mesure de vous proposer des solutions vous permettant d'obtenir certaines des 14 cibles de la **démarche HQE**

2. DOMAINES D'INTERVENTION : ENERGIES RENOUVELABLES

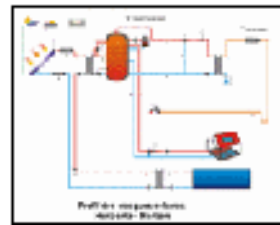

Solaire thermique

Solaire photovoltaïque

Puits canadien

**ENERGIES
RENOUVELABLES**

Solaire passif
Bioclimatisme

Géothermie
Aérothermie

Biomasse,
Biogaz

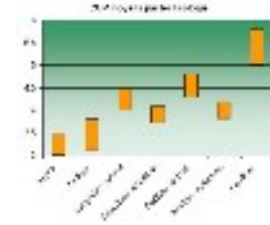
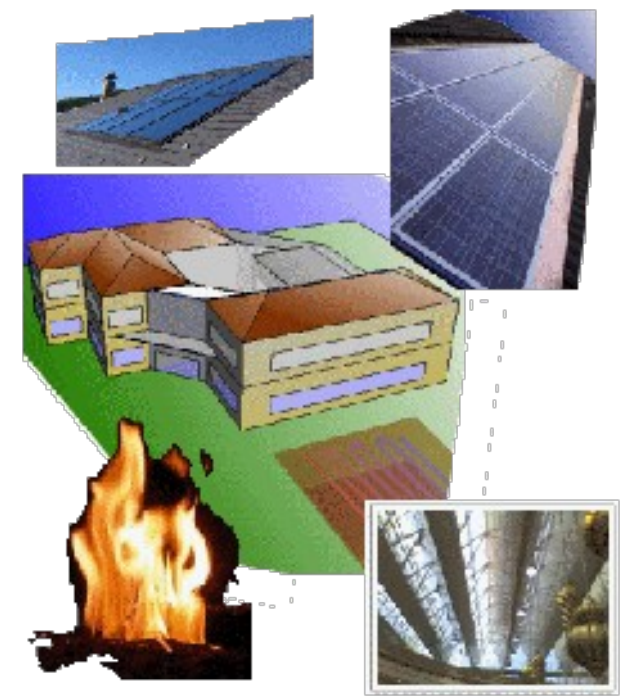

3. METHODES / OUTILS

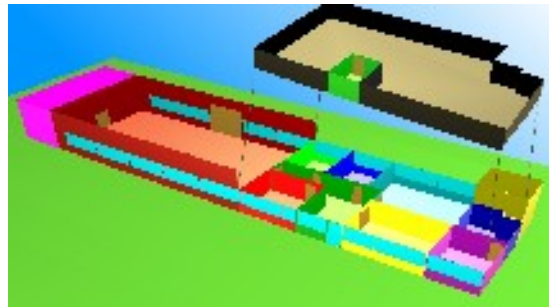

Simulation dynamique

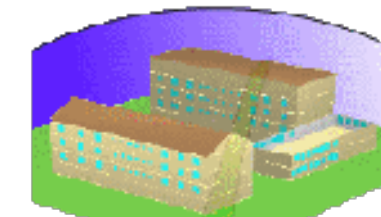
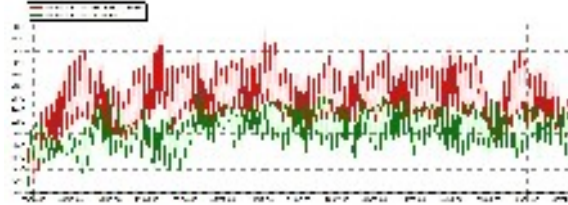

Outils de dimensionnement

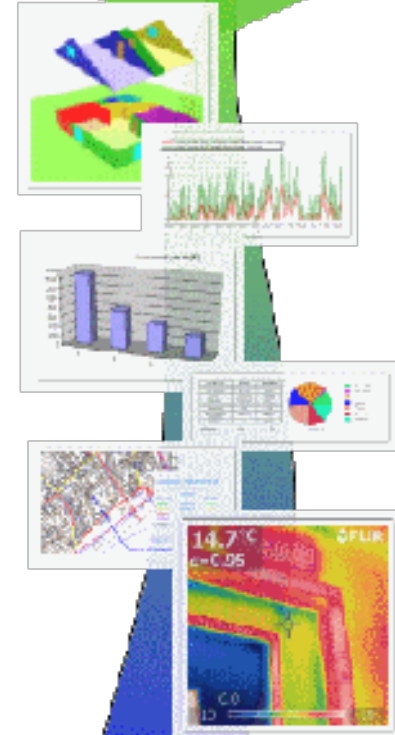

A collage of various data visualization tools including bar charts, pie charts, and maps, representing dimensioning tools.

Outils de mesure

METHODES
OUTILS

Thermographie

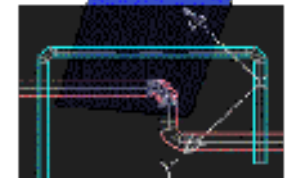
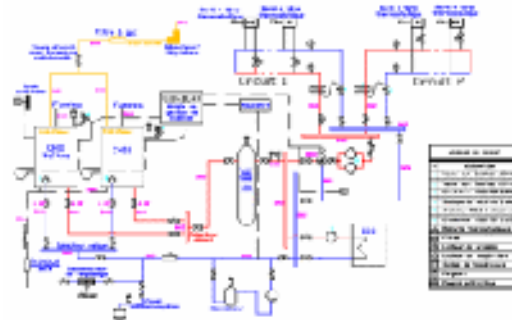
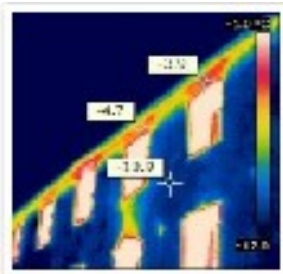

4. REFERENCES



MERCI DE VOTRE ATTENTION !

Contact :

Directeur : Joan BANACH

Ingénieurs : Stéphane PLAYS (thermique) – Marius MENGUE (électrique)

Tel : 01 71 49 10 55

www.efienergies.com